



IT'S TIME

MORE UPTIME • FASTER CYCLE TIME • LONGER LIFETIME

PRODUCT CATALOG

CONNECT WITH US

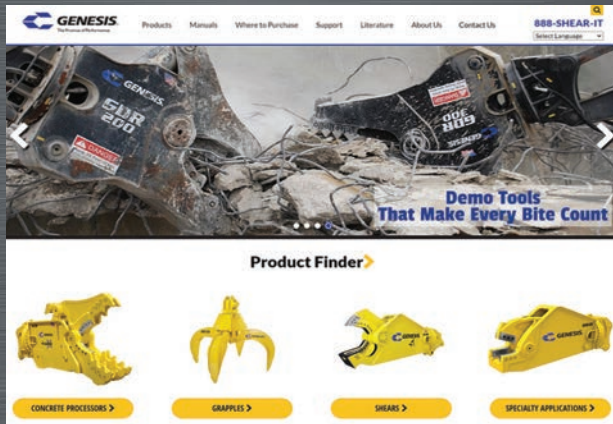

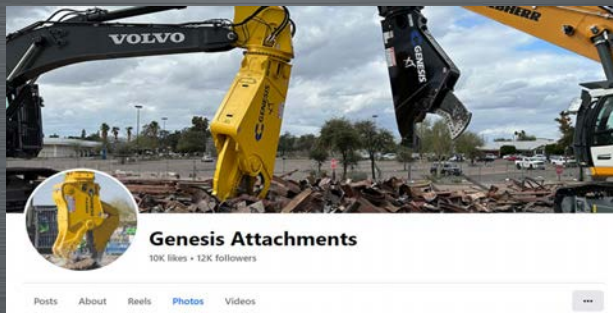

 [genesisattachments.com](https://www.genesisattachments.com)

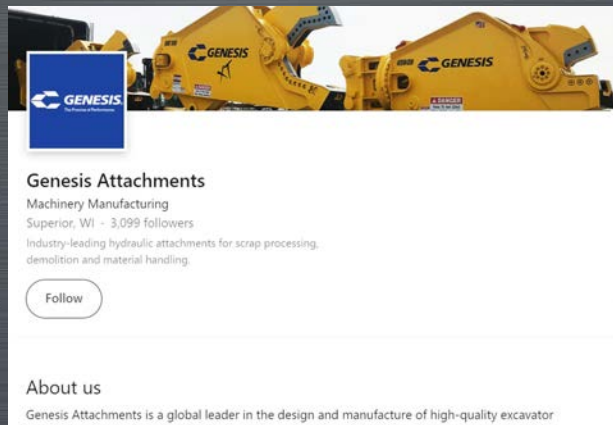

 [facebook.com/genesisattachments](https://www.facebook.com/genesisattachments)



 [linkedin.com/company/genesis-attachments-llc](https://www.linkedin.com/company/genesis-attachments-llc)

 Genesis Attachments
1000 Genesis Drive
Superior, WI 54880 USA

 Toll Free: 888-SHEAR-IT
(888-743-2748)
Phone: 715.395.5252

 info@genesisattachments.com

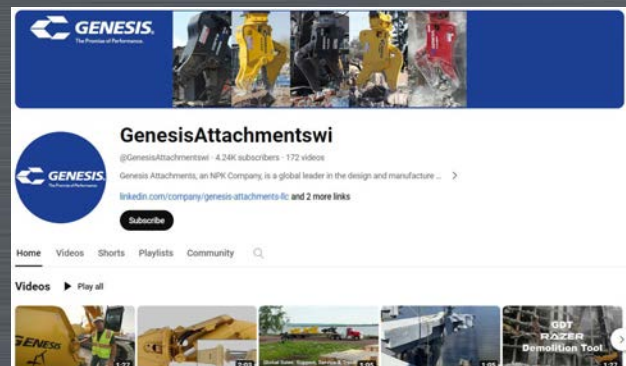

 [youtube.com/genesisattachmentswi](https://www.youtube.com/genesisattachmentswi)

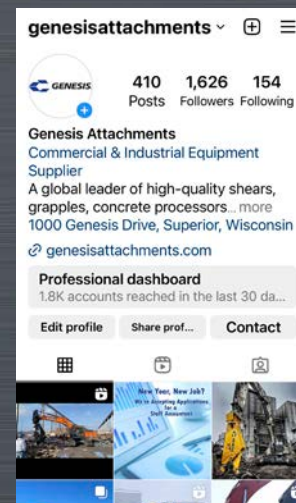

 [instagram.com/genesisattachments](https://www.instagram.com/genesisattachments)

CONTENTS



GXT MOBILE SHEAR PG 4



GRP REBAR PROCESSOR PG 6



GRB RAIL BREAKER PG 7



GDP DEMOPRO PG 8



GSS SUBSEA SHEAR PG 9



M7 CONCRETE CRACKER PG 10



GVP VERSI PRO 07 PG 11



GVP VERSI PRO 15 PG 12



GRS REBAR SHEAR PG 13



GLS LINKAGE SHEAR PG 13



GRX RAZER X PG 14



LXP® LOGIX PROCESSOR PG 16



GDT RAZER PG 18



GDR DEMOLITION RECYCLER PG 19



GCP CONCRETE PROCESSOR PG 20



GCC CONCRETE CRACKER PG 21



GMP D MECH. PULVERIZER D SERIES PG 22



GHG HANDLING GRAPPLE PG 23



GSG SCRAP GRAPPLE PG 24



GSD SEVERE-DUTY GRAPPLE PG 25

TECHNICAL SERVICE TRAINING

PG 26

PARTS

PG 27

REBUILD SERVICES & SHEAR JAW ARMOR®

PG 28

MANUFACTURING

PG 29

MULTI-MACHINE MOUNTING OPTIONS

PG 30

GXT

MOBILE SHEAR

Lower shear height improves visibility while providing superior rigidity and structural integrity

Reverse-mounted hydraulic cylinder shortens shear length and weight while protecting rod from damage

Weld-on, replaceable, highly abrasion-resistant steel rhino horn protects front of upper jaw, reducing downtime and welding build-up

Bolt-on piercing tip encapsulates front of upper jaw, minimizing risk of damage while reducing welding build-up and downtime

Remote-mounted hydraulic speed valve improves serviceability and minimizes stress on other critical hydraulic components

Improved jaw geometry makes it easier to pick up material and reduces wear from ground contact

All the power in a shorter, lighter shear with a center of gravity closer to the excavator. Most models mount on smaller size carriers for lower initial investment and hourly operating costs.

Short primary cutting blades position apex closer to the rear of the jaws and draw material further into the jaws where higher force makes efficient cuts

Dual guide blade length matches piercing tip length enabling blades to be shimmed independently to accommodate piercing tip wear

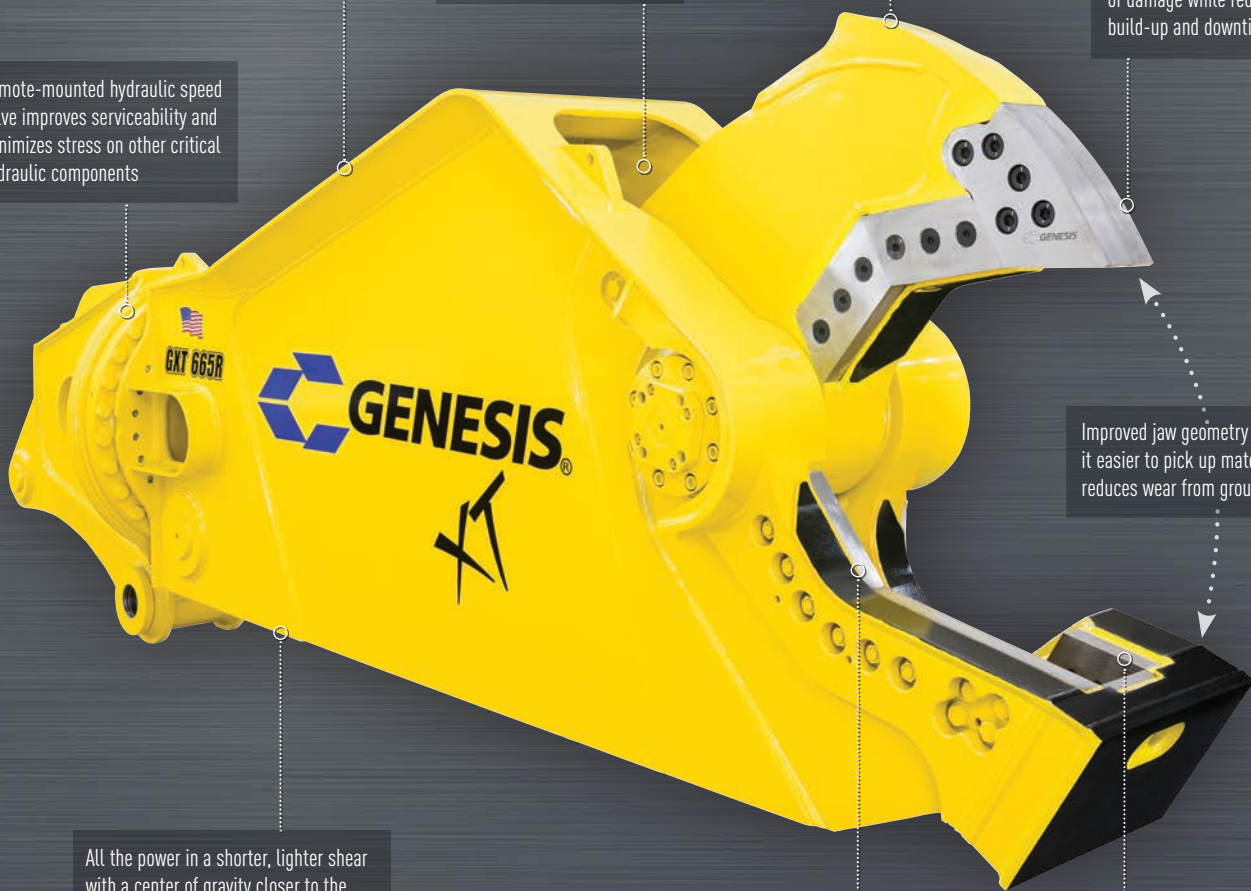



GXT APPLICATIONS

- ▶ Scrap Processing
- ▶ Demolition

| Model | Weight* | Jaw Opening | Jaw Depth | Reach** | Minimum Excavator Weight | |
|---------------------|---------|-------------|-----------|------------|--------------------------|--------------------------|
| | (lbs.) | (ins.) | (ins.) | (ft. ins.) | Boom Mount*** (lbs.) | Stick Mount*** (lbs.) |
| GXT 115**** | 3,100 | 16 | 18 | 5' 0" | 15,000 | 25,000 |
| GXT 115R**** | 3,550 | 16 | 18 | 7' 8" | 18,000 | 30,000 |
| GXT 225 | 4,200 | 18 | 20 | 5' 8" | 25,000 | 35,000 |
| GXT 225R | 4,900 | 18 | 20 | 7' 11" | 30,000 | 45,000 |
| GXT 335 | 6,500 | 23 | 26 | 6' 5" | 27,000 | 45,000 |
| GXT 335R | 7,300 | 23 | 26 | 8' 11" | 37,000 | 66,000 |
| GXT 445 | 9,500 | 28 | 28 | 7' 2" | 40,000 | 75,000 |
| GXT 445R | 11,000 | 28 | 28 | 10' 1" | 48,000 | 90,000 |
| GXT 555 | 11,600 | 30 | 30 | 8' 0" | 50,000 | 90,000 |
| GXT 555R | 13,100 | 30 | 30 | 11' 0" | 55,000 | 110,000 |
| GXT 665 | 13,200 | 32 | 32 | 9' 0" | 55,000 | 110,000 |
| GXT 665R | 14,700 | 32 | 32 | 12' 0" | 68,000 | 120,000 |
| GXT 775 | 15,500 | 35 | 37 | 9' 8" | 68,000 | 135,000 |
| GXT 775R | 17,750 | 35 | 37 | 13' 0" | 79,000 | 150,000 |
| GXT 995 | 18,000 | 39 | 42 | 10' 8" | 79,000 | 170,000 |
| GXT 995R | 20,000 | 39 | 42 | 14' 2" | 100,000 | 180,000 |
| GXT 1555 | 23,000 | 44 | 46 | 13' 5" | 110,000 | 190,000 |
| GXT 1555R | 26,750 | 44 | 46 | 17' 2" | 145,000 | 250,000 |
| GXT 2055 | 32,000 | 48 | 50 | 14' 5" | 145,000 | Contact Factory |
| GXT 2055R | 36,200 | 48 | 50 | 17' 7" | 180,000 | Contact Factory |
| GXT 2555 | 50,500 | 54 | 56 | 15' 5" | Contact Factory | Contact Factory |
| GXT 2555R | 56,500 | 54 | 56 | 21' 5" | Contact Factory | Contact Factory |

*Weight includes mounting bracket to attach to excavator.

**Distance is measured from the attachment mounting pivot (boom or stick) forward.

***2nd-member installations that are at or near minimum excavator weight and all 3rd-member installations require pre-approval from Genesis.

****The GXT 115 and GXT 115R have a single guide blade.

GRP

REBAR PROCESSOR

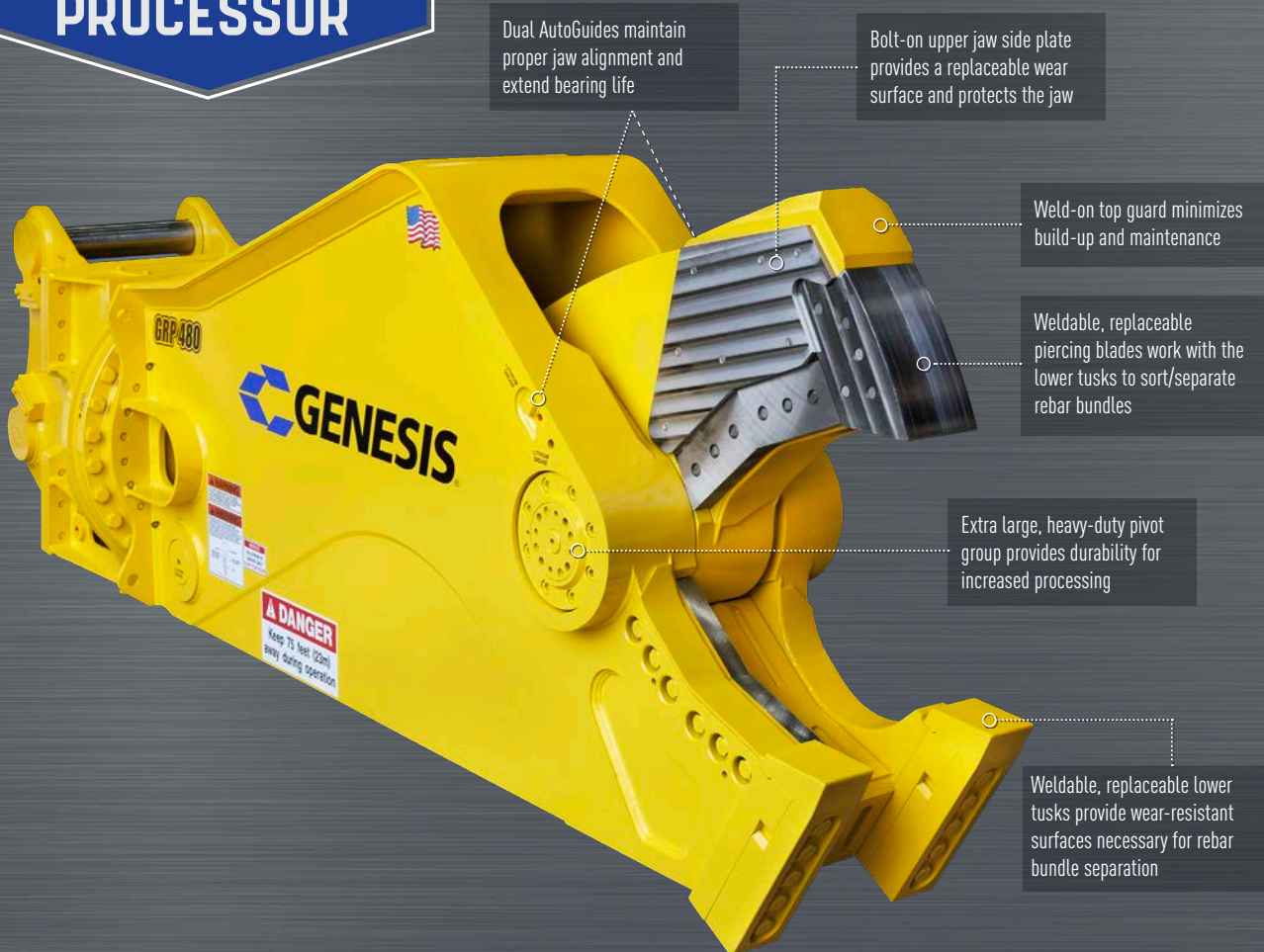

GRP APPLICATIONS

- ▶ Rebar Processing

| Model | Weight* (lbs.) | Jaw Opening (ins.) | Jaw Depth (ins.) | Reach** (ft. ins.) | Minimum Excavator Weight | |
|---------|-------------------|-----------------------|---------------------|-----------------------|--------------------------|--------------------|
| | | | | | Boom Mount (lbs.) | Stick Mount (lbs.) |
| GRP 480 | 11,900 | 24 | 26 | 10' 1" | 48,000 | 90,000 |

*Weight includes mounting bracket to attach to excavator.

**Distance is measured from the attachment mounting pivot (boom or stick) forward.

GRB

RAIL BREAKER

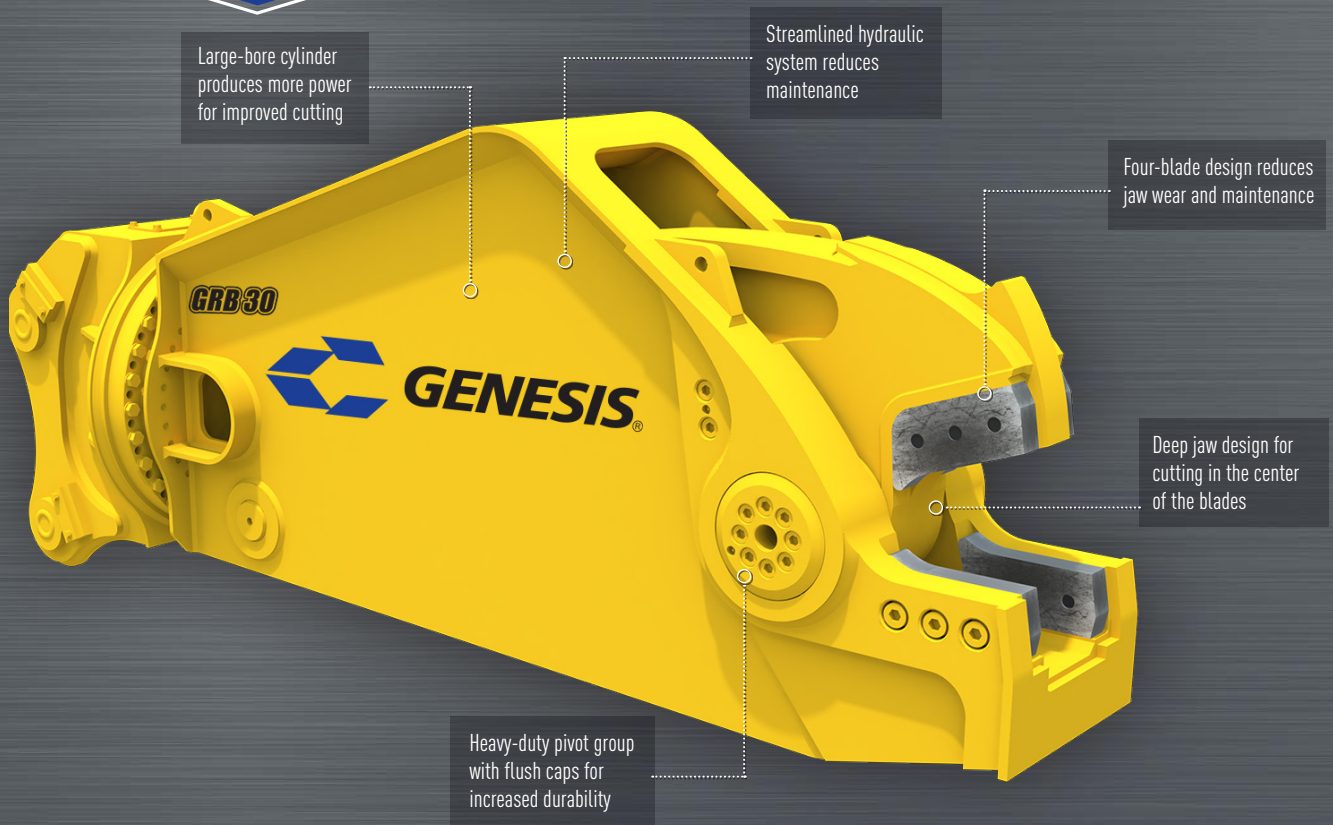

GRB APPLICATIONS

- ▶ Rail Processing
– 136 lb. and smaller low chrome

| Model | Weight* | Jaw Opening | Jaw Depth | Minimum Excavator Weight | |
|--------|---------|-------------|-----------|--------------------------|--------------------|
| | (lbs.) | (ins.) | (ins.) | Boom Mount (lbs.) | Stick Mount (lbs.) |
| GRB 30 | 6,900 | 9.75 | 13.25 | 40,000 | 55,000 |

*Weight includes mounting bracket to attach to excavator.

**Distance is measured from the attachment mounting pivot (boom or stick) forward.

GDP

DEMOPRO

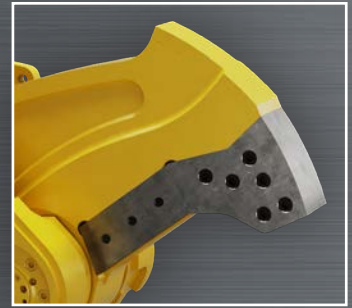

CONCRETE TIP

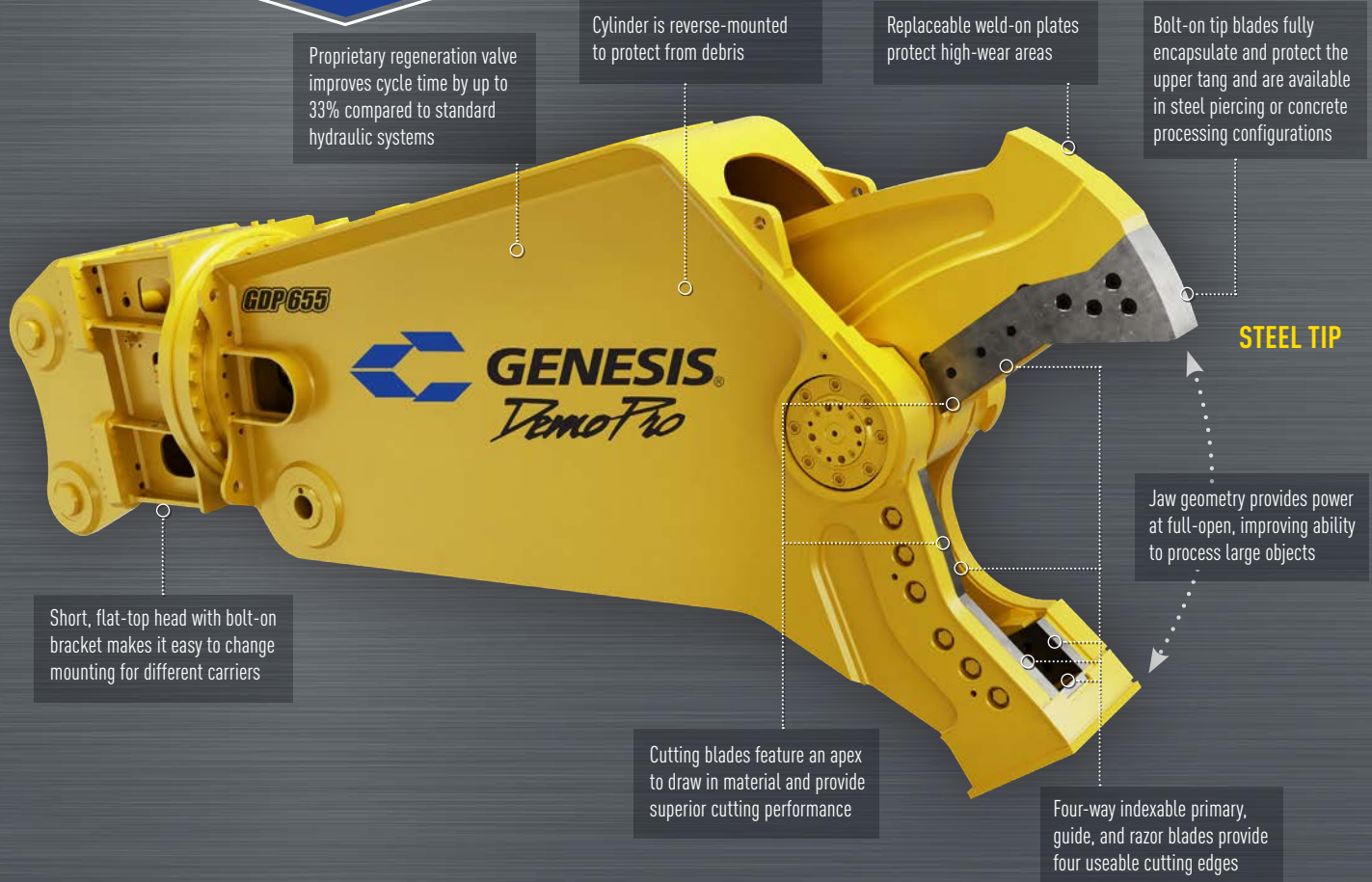

Proprietary regeneration valve improves cycle time by up to 33% compared to standard hydraulic systems

Cylinder is reverse-mounted to protect from debris

Replaceable weld-on plates protect high-wear areas

Bolt-on tip blades fully encapsulate and protect the upper tang and are available in steel piercing or concrete processing configurations

STEEL TIP

Jaw geometry provides power at full-open, improving ability to process large objects

Short, flat-top head with bolt-on bracket makes it easy to change mounting for different carriers

Cutting blades feature an apex to draw in material and provide superior cutting performance

Four-way indexable primary, guide, and razor blades provide four useable cutting edges

GDP APPLICATIONS

- ▶ Demolition
- ▶ Bridge Dismantling and Processing
- ▶ Concrete Recycling

| Model | Weight* | Jaw Opening | | Jaw Depth | Reach** | Minimum Excavator Weight |
|----------------|---------|--------------|-----------------|-----------|------------|--------------------------|
| | (lbs.) | Steel (ins.) | Concrete (ins.) | (ins.) | (ft. ins.) | Stick Mount (lbs.) |
| GDP 655 | 7,500 | 36 | 33 | 26 | 10' 4" | 66,000 |

*Weight includes mounting bracket to attach to excavator.

**Distance is measured from the attachment mounting pivot (boom or stick) forward.

GSS

SUBSEA SHEAR

Multi-position rigging to hang and operate while suspended by a cable crane

Pressure tested to operate at depths down to 10,000 feet

Sealed, greaseable pivot points

Holes for easy draining and flushing

Zinc anodes for galvanic corrosion protection

Exclusive easy-to-shim AutoGuide system helps maintain blade tolerances by off-setting jaw deflection

Anti-corrosion primer and paint for supreme protection in harsh marine environments

EcoGuard anti-corrosion coated fasteners and critical surfaces

Heavy-duty pivot design protected by an anti-corrosion coating provides structural strength and long-term durability

GSS APPLICATIONS

- ▶ Offshore Platform Decommissioning
- ▶ Offshore Pipeline and Piling Cutting
- ▶ Underwater Steel Cutting
- ▶ Cable Hung — Operated by Subsea Power Pack or from Surface Power

| Model | Weight (lbs.) | Jaw Opening (ins.) | Jaw Depth (ins.) |
|----------|------------------|-----------------------|---------------------|
| GSS 665 | 12,300 | 32 | 32 |
| GSS 775 | 14,700 | 35 | 37 |
| GSS 2555 | 46,000 | 54 | 56 |

M7

CONCRETE CRACKER

Available with knock-around rotation or hydraulic rotation

– Knock-around rotation has adjustable brake and position locks

Hydraulic booster for increased power and speed

Fully guarded cylinder rod

Large access panels

Replaceable concrete teeth and blades

Solid Strenx® 900 steel jaws

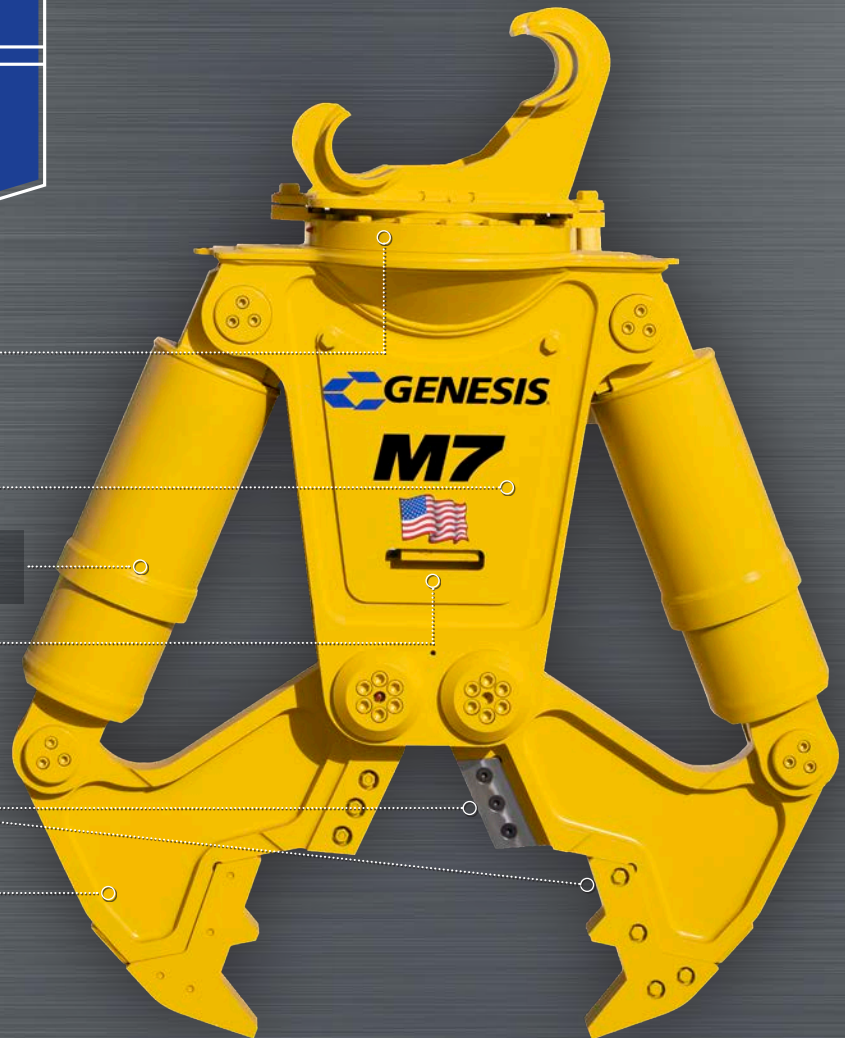

Maintenance and transport stand included

M7 APPLICATIONS

- ▶ Concrete Recycling
- ▶ Demolition

| Model | Weight (lbs.) | Jaw Opening (ins.) | Jaw Depth (ins.) | Brokk® Model | Carrier Weight | |
|-------|---------------|--------------------|------------------|---------------|-------------------|--------------------|
| | | | | | Boom Mount (lbs.) | Stick Mount (lbs.) |
| M7 | 1,400 | 27 | 19 | 400, 500, 520 | 12,000 – 19,000 | 16,000 – 25,000 |

Strenx® is a trademark of the SSAB group of companies.

Brokk® is a trademark of Brokk Global and Lifco Group.

GVP

VERSI PRO 07



Innovative bracket system accommodates a skid steer quick plate or a mini excavator lug plate change-over in 10 minutes

360° rotation comes standard with every Versi Pro

Available with full hydraulic or electric over hydraulic. Electric over hydraulic allows for jaw open or close and rotation with one hydraulic circuit.

Proprietary regeneration valve improves cycle time by up to 33% compared to standard hydraulic systems

Jaw change-outs in 10 minutes with the coupler-style connection system

Each jaw's pivot group stays intact, allowing the use of a press-fit pin design for a stronger, more durable product and making jaw change-outs safe, easy and fast



SHEAR JAW

- ▶ Patented pivot geometry creates peak power for piercing and cutting
- ▶ Weld-on wear plate and piercing tip
- ▶ Four-way indexable guide blades and primary blades provide four useable cutting edges



CRACKER JAW

- ▶ Patented pivot geometry creates peak power when jaws are fully open, where it's most needed to crush concrete
- ▶ Open relief design allows concrete to pass through lower jaw



GRAPPLE JAW

- ▶ Recessed welds are protected from wear, increasing grapple life
- ▶ Boxed-tine construction creates a very high strength and lightweight grapple—each tine will withstand the full breakout force of the carrier
- ▶ Replaceable tine tips are abrasion-resistant
- ▶ Inside radius matches that of a 55-gallon barrel



WIRE CUTTER JAW

- ▶ Designed for non-ferrous wire only
- ▶ Bolt-on interchangeable cutting blades can be sharpened and are easily replaced
- ▶ Curved jaw design gathers material deeper into the jaw for maximum cutting power
- ▶ Unique self-tensioning pivot group maintains optimal blade clearance



Skid Steer Bracket

Mounting bracket option for skid steers features a traction grip to provide safe entry and exit for the operator

| Jaws | Weight* | Jaw Opening | Jaw Depth | Reach** w/Jaws Installed | Minimum Excavator Weight | | Minimum Skid Steer Weight (lbs.) |
|-------------|---------|-------------|-----------|-----------------------------|--------------------------|-----------------------|-------------------------------------|
| | (lbs.) | (ins.) | (ins.) | (ft. ins.) | Boom Mount (lbs.) | Stick Mount (lbs.) | |
| Shear | 1,375 | 11.5 | 11.5 | 5' 6" | 12,000 | 16,000 | 7,000 |
| Cracker | 1,385 | 14.5 | 13 | 5' 8" | | | |
| Grapple | 1,420 | 32 | 15.5 | 5' 11" | | | |
| Wire Cutter | 1,245 | 10.5 | 11.5 | 5' 9" | | | |

GVP 07 APPLICATIONS

- ▶ Interior Demolition
- ▶ Scrap Processing
- ▶ On-site Material Processing and Handling

*Weight includes mounting bracket to attach to excavator.

**Distance is measured from the attachment mounting pivot (boom or stick) forward.

The stability of each lift class varies between OEM skid steer and mini excavator models. Please consult with your Genesis salesperson for recommended carrier models. Joystick control packages are available for carriers less equipped.

GVP

VERSI PRO 15

Patented pivot system provides a power curve to match each jaw set's primary application

Each jaw's pivot group stays intact, allowing the use of a press-fit pin design for a stronger, more durable product and making jaw change-outs safe, easy and fast

Proprietary regeneration valve improves cycle time by up to 33% compared to standard hydraulic systems

360° rotation comes standard with every Versi Pro

Jaw change-outs in 10 minutes with the coupler-style connection system



SHEAR JAW

- ▶ Patented bolt-on piercing tip is replaced in minutes without grinding or welding
- ▶ Four-way indexable guide blades, razor blade and primary blades provide four useable cutting edges
- ▶ Exclusive dual guide blade system accommodates heat expansion at the tip while maintaining tighter tolerances where the primary cutting blades pass



CRACKER JAW

- ▶ Offset teeth rows maximize the ability to downsize material
- ▶ Patented pivot geometry creates peak power when jaws are near wide open, where it's most needed to crush concrete

GVP 15 APPLICATIONS

SHEAR JAW

- ▶ Scrap Processing
- ▶ Demolition
- ▶ Rebar
- ▶ Wire
- ▶ Tires
- ▶ Many Types of Non-ferrous

CRACKER JAW

- ▶ Demolition
- ▶ Concrete Recycling
- ▶ C & D Processing

| Jaws | Weight* | Jaw Opening | Jaw Depth | Reach** | Minimum Excavator Weight | |
|---------|---------|-------------|-----------|------------|--------------------------|--------------------|
| | (lbs.) | (ins.) | (ins.) | (ft. ins.) | Boom Mount (lbs.) | Stick Mount (lbs.) |
| Shear | 3,200 | 16 | 15 | 7' 5" | 18,000 | 28,000 |
| Cracker | 3,200 | 25 | 25 | 8' 3" | | |

*Weight includes mounting bracket to attach to excavator.

**Distance is measured from the attachment mounting pivot (boom or stick) forward. The stability of each lift class varies between OEM excavator models. Please consult with your Genesis salesperson for recommended carrier models.

GRS

REBAR SHEAR

GLS

LINKAGE SHEAR

Rhino horn designed to aid in positioning material for processing

Common pivot group and pinning points accommodate the GRS and GLS with one stiff arm—the mounting pad remains in place

Patented bolt-on piercing tip is replaced in minutes without grinding or welding

Shrouded heavy-duty pivot design provides structural strength and long-term durability

Four-way indexable blades provide four useable cutting edges

Four-way indexable guide blades, razor blade and primary blades provide four useable cutting edges

Staggered jaws make two cuts with each cycle, applying maximum force to each cut

16-inch cut length for higher value end product

Cutaway chin plate provides a relief area for balled rebar while maintaining the rigid structural integrity of the lower jaw

POWER Series

GRS & GLS APPLICATIONS

- ▶ Scrap Processing
- ▶ Demolition
- ▶ C & D Processing
- ▶ Concrete Recycling

STIFF ARM AND MOUNTING PAD

Comes standard with each GRS and GLS



| Model | Weight* (lbs.) | Jaw Opening** (ins.) | Jaw Depth (ins.) | Excavator Weight (lbs.) |
|--------|-------------------|-------------------------|---------------------|----------------------------|
| GRS 70 | 6,098 | 26 | 27 | 65,000-80,000 |
| GRS 90 | 6,718 | 30 | 30 | 80,000-110,000 |

*Weight includes mounting bracket and stiff arm.
 **Jaw opening varies slightly depending on excavator mounting location.
 Genesis linkage attachments are not compatible with quick couplers.
 Contact Genesis for more information.

| Model | Weight* (lbs.) | Jaw Opening** (ins.) | Jaw Depth (ins.) | Excavator Weight (lbs.) |
|--------|-------------------|-------------------------|---------------------|----------------------------|
| GLS 50 | 4,100 | 21 | 21 | 40,000-60,000 |
| GLS 70 | 4,696 | 24 | 24 | 60,000-80,000 |
| GLS 90 | 5,313 | 27 | 27 | 80,000-110,000 |

*Weight includes mounting bracket and stiff arm.
 **Jaw opening varies slightly depending on excavator mounting location.
 Genesis linkage attachments are not compatible with quick couplers.
 Contact Genesis for more information.

GRX

RAZER X MULTI-JAW DEMOLITION TOOL

CRACKER JAW

Reversible, long-life crushing teeth are quickly and easily replaced, eliminating build-up

4-way indexable cutting blades feature an apex that draws material deeper into the jaw for more efficient cutting

Easy-to-change crushing teeth are available in several configurations to maximize performance in any application

Heavy-duty pivot design is integral to the jaw set, providing a power curve to match the jaw's primary application

Reverse-mounted cylinder protects the rod from debris

Short, flat-top head with bolt-on bracket shortens the center of gravity, making it easy to change mounting for different carriers



Hydraulic pin engagement and removal for jaw change-outs in less than 2 minutes without leaving the cab

Proprietary regeneration valve improves cycle time by up to 33% compared to standard hydraulic systems

SHEAR JAW

Weld-on, replaceable, highly abrasion-resistant steel rhino horn protects front of upper jaw, reducing maintenance

Bolt-on piercing tip encapsulates front of upper jaw, minimizing risk of damage and reducing maintenance

Dual guide blade length matches piercing tip length so blades can be shimmed independently to accommodate piercing tip wear





PULVERIZER JAW



SHEAR JAW STAND

Jaw stands are specific to each jaw set, providing correct positioning for efficient change-outs

Extended wear plates aid in positioning concrete for processing

Indexable blades provide two usable edges

Reversible, long-life crushing teeth are quickly and easily replaced, eliminating build-up



GRX APPLICATIONS

- ▶ Concrete Recycling
- ▶ C & D Processing
- ▶ Bridge Demolition
- ▶ Wire
- ▶ Copper
- ▶ Structural Steel
- ▶ Demolition
- ▶ Rebar
- ▶ Aluminum

| Model | Jaw | Weight* | Jaw Opening | Jaw Depth | Reach** | Minimum Excavator Wt. |
|---------|------------|---------|-------------|-----------|---------|-----------------------|
| | | (lbs.) | (ins.) | (ins.) | | (ft. ins.) |
| GRX 195 | Cracker | 5,500 | 30 | 30 | 8' 9" | 45,000 |
| | Shear | 5,200 | 18 | 18 | | |
| | Pulverizer | 5,500 | 29 | 26 | | |
| GRX 295 | Cracker | 7,100 | 38 | 32 | 9' 4" | 66,000 |
| | Shear | 6,900 | 20 | 20 | | |
| | Pulverizer | 7,300 | 38 | 30 | | |
| GRX 395 | Shear | 10,500 | 24 | 25.5 | 10' 6" | 90,000 |
| | Cracker | 10,750 | 45 | 42 | | |
| | Pulverizer | 11,000 | 45 | 36 | | |



*Weight includes mounting bracket to attach to excavator.

**Distance is measured from the attachment mounting pivot (boom or stick) forward.

LXP[®]

LOGIX PROCESSOR

Patented pivot system provides a power curve to match the jaw's primary application:

- peak power at pierce for shear jaw
- peak power at fully open for cracker and pulverizer jaws

Each jaw's pivot group stays intact, allowing the use of a press fit design for a stronger, more durable product

Reverse-mounted cylinders protect the rods from debris

Proprietary regeneration valve improves cycle time by up to 33% compared to standard hydraulic systems

SHEAR JAW

Patented bolt-on piercing tip is replaced in minutes without grinding or welding

Four-way indexable guide blades, razor blade and primary blades provide four useable cutting edges

Exclusive dual guide blade system accommodates heat expansion at the tip while maintaining tighter tolerances where the primary cutting blades pass (300 - 800 models only)

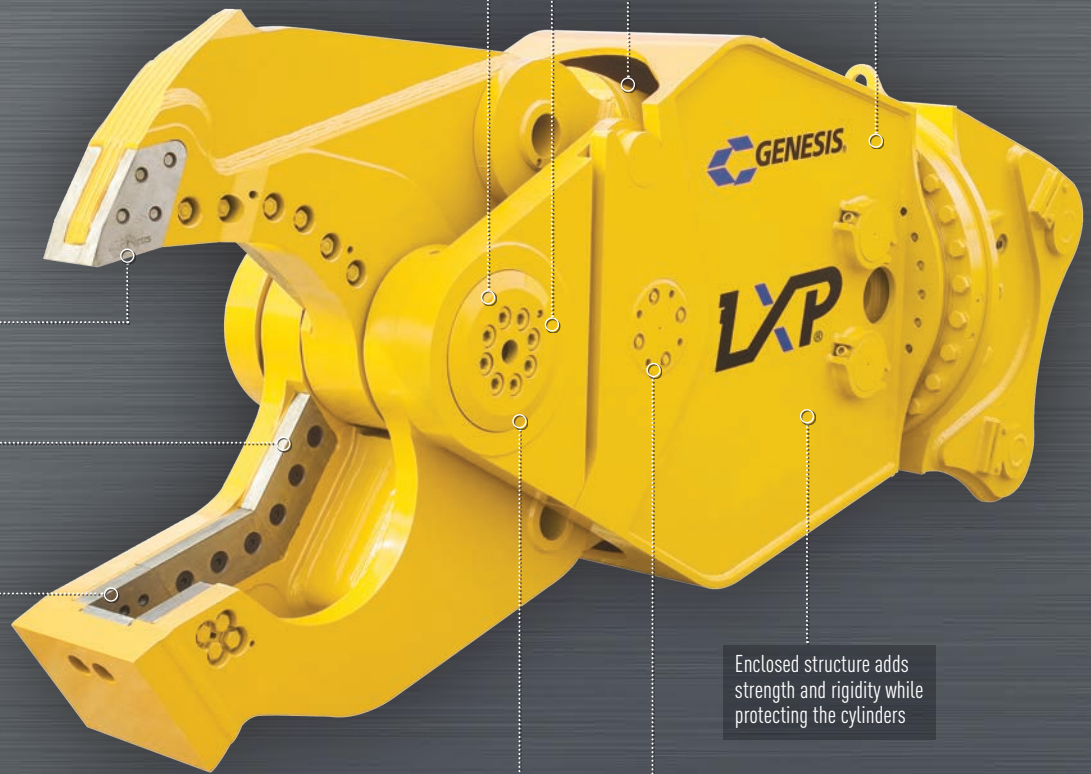

Enclosed structure adds strength and rigidity while protecting the cylinders

Heavy-duty pivot design with recessed caps provides structural strength and long-term durability

Jaw change-outs in 15 minutes with the coupler style connection system, hydraulically activated lock pin, jaws that stay intact and a stand with every jaw set - safe, easy and fast



JAW STANDS

LXP 200 & 300: 680 lbs.
LXP 400 & 500: 780 lbs.
LXP 800: 1,100 lbs.

CRACKER JAW 200-500

Teeth are easy to change and fully protect the parent material, eliminating the need for build-up and hard-surfacing (200-500 models only)

Indexable blades provide two useable cutting edges

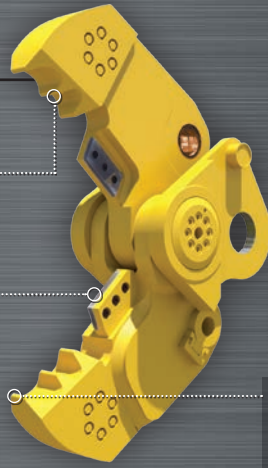

Bolt-on teeth and blades reduce maintenance and downtime (800 model only)

Indexable blades provide two useable cutting edges

Cracker tips concentrate force for a greater ability to crush through heavy concrete

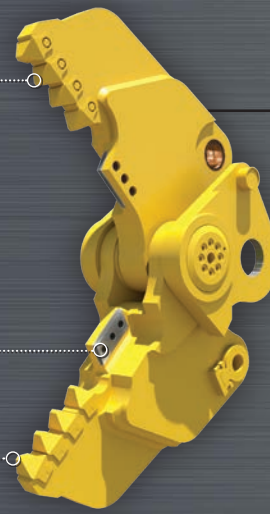

CRACKER JAW 800

PULVERIZER JAW 200-500

Bolt-on tooth bed features a fully replaceable crushing surface, eliminating the need for welding (200-500 models only)

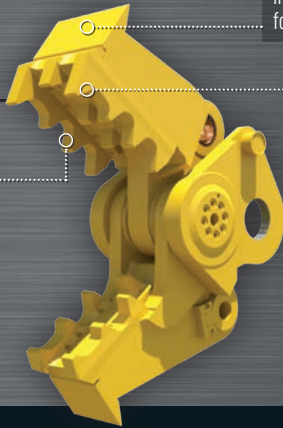

Extended wear plates aid in positioning concrete for processing

Tips concentrate force for a greater ability to crush through heavy concrete

Bolt-on teeth reduce maintenance and downtime (800 model only)

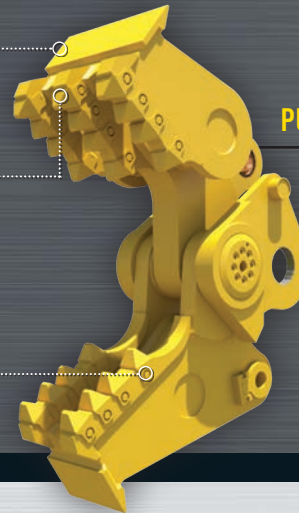

PULVERIZER JAW 800

LXP® APPLICATIONS

SHEAR JAW

- ▶ Demolition
- ▶ Bridge Demolition
- ▶ Structural Steel
- ▶ Rebar
- ▶ Wire
- ▶ Aluminum
- ▶ Copper

CRACKER JAW

- ▶ Concrete Recycling
- ▶ C & D Processing
- ▶ Rebar
- ▶ Demolition

PULVERIZER JAW

- ▶ Demolition
- ▶ Concrete Recycling
- ▶ C & D Processing
- ▶ Rebar

| Model | | Weight* | Jaw Opening | Jaw Depth | Reach** | Minimum Excavator Weight | |
|---------|------------|---------|-------------|-----------|---------|--------------------------|--------------------|
| | | (lbs.) | (ins.) | (ins.) | | Boom Mount (lbs.) | Stick Mount (lbs.) |
| LXP 200 | Shear | 5,370 | 17 | 19 | 8' 0" | 20,000 | 45,000 |
| | Pulverizer | 5,670 | 29 | 24 | | | |
| | Cracker | 5,650 | 38 | 28 | | | |
| LXP 300 | Shear | 7,600 | 22 | 24 | 8' 6" | 45,000 | 70,000 |
| | Pulverizer | 7,270 | 35 | 26 | | | |
| | Cracker | 7,560 | 43 | 30 | | | |
| LXP 400 | Shear | 11,065 | 24 | 27 | 9' 6" | 60,000 | 100,000 |
| | Pulverizer | 11,255 | 38 | 30 | | | |
| | Cracker | 11,145 | 47 | 33.5 | | | |
| LXP 500 | Shear | 12,905 | 27 | 28 | 9' 11" | 70,000 | 120,000 |
| | Pulverizer | 12,205 | 43 | 31 | | | |
| | Cracker | 12,715 | 51 | 34.5 | | | |
| LXP 800 | Shear | 17,500 | 40 | 35 | 11' 8" | 90,000 | 150,000 |
| | Pulverizer | 17,720 | 61 | 39 | | | |
| | Cracker | 17,600 | 71 | 50 | | | |

*Weight includes mounting bracket to attach to excavator.

**Distance is measured from the attachment mounting pivot (boom or stick) forward.



GDT

RAZER DEMOLITION TOOL

Cylinder is reverse-mounted to protect from debris

Short, flat-top head with bolt-on bracket shortens the center of gravity while making it easy to change mounting for different carriers

Reversible, long-life crushing teeth are quickly and easily replaced, eliminating build-up

4-way indexable cutting blades feature an apex that draws material deeper into the jaw for more efficient cutting

Open lower jaw allows material being processed to easily pass through, preventing jamming

Easy-to-change crushing teeth are available in several configurations to maximize performance in any application

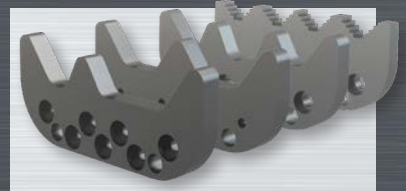

GDT APPLICATIONS

- ▶ High-Reach Demolition
- ▶ Concrete Recycling
- ▶ C & D Processing
- ▶ Bridge Demolition
- ▶ Wire
- ▶ Copper
- ▶ Structural Steel
- ▶ Demolition
- ▶ Rebar
- ▶ Aluminum

| Model | Weight* | Jaw Opening | Jaw Depth | Reach** | Minimum Excavator Wt. |
|----------------|---------|-------------|-----------|------------|-----------------------|
| | (lbs.) | (ins.) | (ins.) | (ft. ins.) | Stick Mount (lbs.) |
| GDT 190 | 4,900 | 31 | 33 | 8' 0" | 45,000 |
| GDT 290 | 7,000 | 39 | 42 | 9' 2" | 66,000 |
| GDT 390 | 10,000 | 46 | 45 | 10' 6" | 90,000 |
| GDT 590 | 15,100 | 52 | 46.5 | 12' 4" | 120,000 |
| GDT 890 | 20,000 | 64 | 62 | 13' 10" | 180,000 |

*Weight includes mounting bracket to attach to excavator.

**Distance is measured from the attachment mounting pivot (boom or stick) forward.

GDR

DEMOLITION RECYCLER



Extended upper plate aids in positioning concrete for processing

Reverse-mounted cylinder protects cylinder rod from debris

360° rotation comes standard with every GDR

300/400 CRACKER JAW CONFIGURATION

Weld-on tooth and blade pockets greatly improve the ability to maintain the jaws, extending the GDR's useful life

Indexable blades provide two useable cutting edges

Bolt-on teeth and blades reduce maintenance time

Extended chin aids in positioning concrete for processing

Heavy-duty pivot design with recessed end caps provides structural strength and long-term durability

Combination of a large-bore cylinder and a regeneration valve eliminates the need for an intensifier and a complex hydraulic system

JAW CONFIGURATIONS

GDR APPLICATIONS

- ▶ Concrete Recycling
- ▶ Bridge Demolition
- ▶ C & D Processing
- ▶ Structural Steel
- ▶ Demolition
- ▶ Rebar
- ▶ Wire
- ▶ Aluminum
- ▶ Copper



Pulverizer
150 & 200 models



Pulverizer
300 & 400 models



Cracker
150 & 200 models



Shear
150, 200 & 300 models only

| Model | Weight* (lbs.) | Jaw Opening (ins.) | Jaw Depth (ins.) | Reach** (ft. ins.) | Minimum Excavator Wt. Stick Mount (lbs.) |
|----------------|-------------------|-----------------------|---------------------|-----------------------|---|
| GDR 150 | 3,450 | 26 | 25 | 6' 4" | 28,000 |
| GDR 200 | 5,500 | 35 | 32 | 7' 7" | 45,000 |
| GDR 300 | 7,900 | 43 | 39 | 8' 9" | 70,000 |
| GDR 400 | 11,000 | 48 | 41 | 9' 10" | 100,000 |

*Weight includes mounting bracket to attach to excavator.
**Distance is measured from the attachment mounting pivot (boom or stick) forward.

GCP

CONCRETE PROCESSOR



Proprietary regeneration valve improves cycle time by up to 33% compared to standard hydraulic systems

Heavy-duty pivot design with recessed end caps provides structural strength and long-term durability

Unique bolt-on wear parts quickly separate rebar from concrete

One-piece bolt-on tooth bed and bottom wear pad protect parent material, are quick and easy to replace, and minimize build-up and hard-surfacing

Large jaw opening readily pulverizes thick concrete

Bolt-on rebar cutting blades and weld-in blade pockets are easy to replace and reduce maintenance

GCP APPLICATIONS

- ▶ Concrete Recycling
- ▶ Demolition

| Model | Weight* | Jaw Opening | Jaw Depth | Jaw Width | Reach** | Minimum Excavator Wt. |
|-----------------|---------|-------------|-----------|-----------|------------|-----------------------|
| | (lbs.) | (ins.) | (ins.) | (ins.) | (ft. ins.) | Stick Mount (lbs.) |
| GCP 410 | 4,650 | 34 | 29 | 20 | 6' 9" | 45,000 |
| GCP 410R | 6,650 | 34 | 29 | 20 | 7' 9" | 55,000 |
| GCP 610 | 10,350 | 49 | 40 | 30 | 8' 8" | 75,000 |
| GCP 610R | 11,550 | 49 | 40 | 30 | 9' 8" | 95,000 |

*Weight includes mounting bracket to attach to excavator.

**Distance is measured from the attachment mounting pivot (boom or stick) forward.

GCC

CONCRETE CRACKER



Common pivot group and pinning points accommodate the GCC with one stiff arm—the mounting pad remains in place

Shrouded heavy-duty pivot design provides structural strength and long-term durability

Blade profile focuses force for optimal concrete processing and rebar cutting

Bolt-on wear parts can be rotated, maximizing blade life and minimizing downtime

Extended chin blade aids in positioning concrete for processing

POWER Series

GCC APPLICATIONS

- ▶ Scrap Processing
- ▶ Demolition
- ▶ C & D Processing
- ▶ Concrete Recycling

STIFF ARM AND MOUNTING PAD

Comes standard with each GCC



| Model | Weight* | Jaw Opening** | Excavator Weight |
|---------------|---------|---------------|------------------|
| | (lbs.) | (ins.) | (lbs.) |
| GCC 50 | 4,400 | 29 | 40,000-60,000 |
| GCC 70 | 4,990 | 32 | 60,000-80,000 |
| GCC 90 | 5,170 | 36 | 80,000-110,000 |

*Weight includes mounting bracket and stiff arm.

**Jaw opening varies slightly depending on excavator mounting location.

Genesis linkage attachments are not compatible with quick couplers. Contact Genesis for more information.

GMP D

MECHANICAL PULVERIZER D SERIES

GMP 50D / 70D WELD-IN TEETH JAW CONFIGURATION

Weld-in teeth can be rebuilt in place for extended life

Extended link pin position provides optimal power

GMP 50D / 70D BOLT-IN TEETH JAW CONFIGURATION

Bolt-in teeth are easily replaced in the field for minimal downtime and can be rotated front to back for longer life

Pass-through jaw design provides easy material processing and prevents jamming

All teeth extend beyond chin to protect parent steel from wear and abrasion

Extended chin blade aids in positioning concrete for processing



| Model | Weight* | Jaw Opening** | Jaw Depth | Moving Jaw Width | Fixed Jaw Width | Tooth Config. | Excavator Weight |
|----------------|---------|---------------|-----------|------------------|-----------------|---------------|------------------|
| | (lbs.) | (ins.) | (ins.) | (ins.) | (ins.) | | (lbs.) |
| GMP 50D | 4,650 | 36 | 25 | 24 | 32 | 3/4 | 40,000-60,000 |
| GMP 70D | 5,050 | 40 | 29 | 26.5 | 34 | 4/5 | 60,000-80,000 |
| GMP 90D | 6,400 | 44 | 32.5 | 32.5 | 40 | 4/5 | 80,000-110,000 |

*Weight includes mounting bracket and stiff arm.

**Jaw opening varies slightly depending on excavator mounting location.



STIFF ARM AND MOUNTING PAD

Comes standard with each GMP D

GMP D APPLICATIONS

- ▶ Demolition
- ▶ C & D Processing
- ▶ Concrete Recycling

GHG

HANDLING GRAPPLE

Hydraulic side connections

No case drain line needed

Powerful hydraulic rotation motor

Easy accessibility for rotation speed adjustment

Pilot check valve prevents unexpected opening of the arms

Break valves integrated into the hydraulic motor

Hydraulic cylinder with cushion at the end of the opening

High-wear areas manufactured of abrasion-resistant Hardox®

Cutters feature a hardness of 500HB

Oversized main pins combined with wear bushings and sealed with O-rings

Easy maintenance

GHG APPLICATIONS

- ▶ Waste Handling and Recycling
- ▶ C & D Material Handling and Sorting
- ▶ Primary Demolition

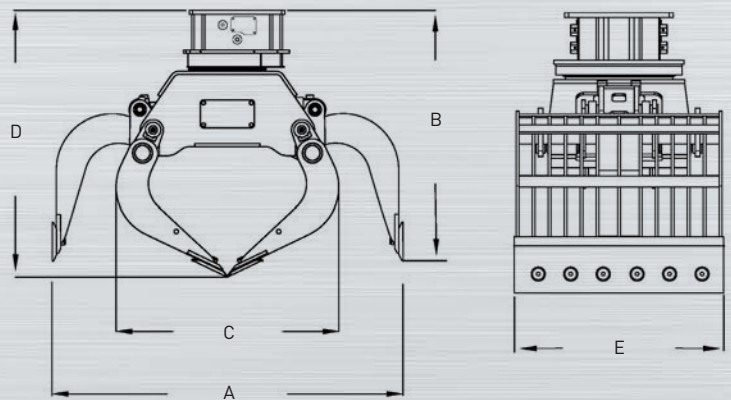

| Model | DIAGRAM DIMENSION | | A | B | C | D | E | Minimum Machine Size (mt) |
|--------|-------------------|---------------|-----------------------|------------------------|-------------------------|--------------------------|-----------------------------|---------------------------|
| | Capacity (yd³) | Weight (lbs.) | Jaw Open Width (ins.) | Jaw Open Height (ins.) | Jaw Closed Width (ins.) | Jaw Closed Height (ins.) | Tine Width Footprint (ins.) | |
| GHG 16 | 0.6 | 1,929 | 73 | 49 | 48 | 54 | 34 | 10-16 |
| GHG 20 | 0.65 | 2,712 | 81 | 51 | 52 | 57 | 37 | 14-20 |
| GHG 25 | 0.8 | 3,197 | 85 | 52 | 52 | 59 | 44 | 16-26 |
| GHG 30 | 1.0 | 4,079 | 95 | 58 | 62 | 65 | 44 | 18-30 |
| GHG 40 | 1.2 | 4,519 | 95 | 58 | 62 | 65 | 54 | 25-40 |
| GHG 50 | 1.4 | 5,512 | 96 | 61 | 66 | 65 | 57 | 35-50 |

Hardox® is a trademark of the SSAB group of companies.

GSG

SCRAP GRAPPLE

High-torque continuous 360° rotation for handling large and uneven loads

Heavy-duty guarding system completely protects cylinders and internal components, removes easily for internal maintenance access

Large bore hydraulic cylinders maximize clamping force

Long-life, abrasion-resistant steel tips are easily replaced with simple perimeter weld

Large diameter hardened steel pins with integrated shear-proof pin retainers

All tine styles feature fully boxed construction for strength and durability



GSG APPLICATIONS

- ▶ Scrap Handling
- ▶ C & D Sorting
- ▶ Bulk Material Handling

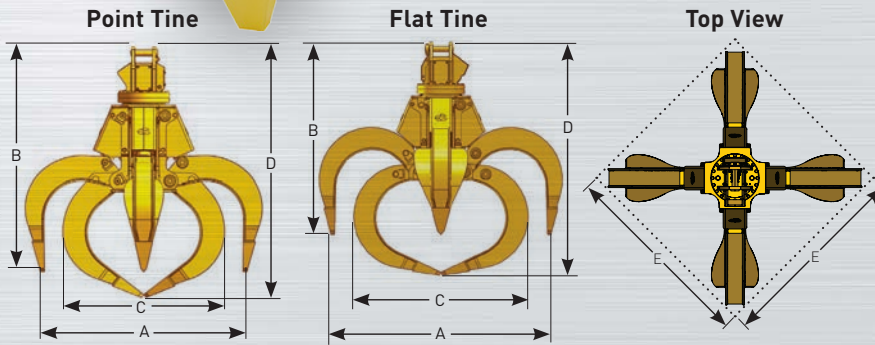

TINE CONFIGURATIONS

Flat tine models 50-125 available with wide spades

Point tine available with medium spades only

Flat tine models 50-250 available with medium spades



| Model | DIAGRAM DIMENSION | | | A | | B | | C | | D | | E | |
|--------------------|-----------------------------|-----------------|------------------------|-----------------------|------------|------------------------|------------|-------------------------|------------|--------------------------|------------|------------------|------------|
| | Capacity (yd ³) | Weight** (lbs.) | Min. Machine Size (mt) | Jaw Open Width (ins.) | | Jaw Open Height (ins.) | | Jaw Closed Width (ins.) | | Jaw Closed Height (ins.) | | Footprint (ins.) | |
| | | | | Flat Tine | Point Tine | Flat Tine | Point Tine | Flat Tine | Point Tine | Flat Tine | Point Tine | Flat Tine | Point Tine |
| GSG 50 | 0.50 | 3,050 | 20 | *** | 64 | *** | 81 | *** | 52 | *** | 88 | *** | 60 |
| GSG 65 | 0.65 | 3,150 | 20 | *** | 69 | *** | 83 | *** | 54 | *** | 91 | *** | 64 |
| GSG 75 | 0.75 | 3,250 | 20 | 74 | 76 | *** | 85 | *** | 59 | 91 | 95 | *** | 70 |
| GSG 100 | 1 | 3,500 | 22 | 79 | 80 | *** | 90 | *** | 68 | 93 | 100 | *** | 73 |
| GSG 100 HD* | 1 | 4,300 | 25 | 78 | 79 | 77 | 86 | 66 | 63 | 91 | 98 | 71 | 72 |
| GSG 125 | 1.25 | 3,600 | 22 | 89 | 86 | *** | 92 | *** | 71 | 98 | 101 | *** | 79 |
| GSG 125 HD* | 1.25 | 4,500 | 27 | 85 | 86 | 79 | 88 | 71 | 67 | 95 | 102 | 77 | 78 |
| GSG 150 | 1.5 | 4,800 | 30 | 91 | 89 | 81 | 94 | 75 | 72 | 100 | 108 | 80 | 81 |
| GSG 200 | 2 | 5,000 | 40 | 96 | 95 | 82 | 96 | 78 | 76 | 103 | 112 | 84 | 86 |
| GSG 250 | 2.5 | 5,700 | 45 | 108 | 105 | 84 | 100 | 86 | 85 | 109 | 118 | 94 | 95 |

*Heavy-duty
**Weight includes yoke.

***Contact your local Genesis Regional Manager for additional information.

GSD

SEVERE-DUTY GRAPPLE



Patented pivot group features a large pivot shaft, and bearings provide long-term durability

Recessed welds are protected from wear, increasing grapple life

Replaceable tine tips are abrasion-resistant Hardox® steel

Boxed-tine construction creates a very high strength and lightweight grapple — each tine will withstand the full breakout force of the excavator

GSD APPLICATIONS

- ▶ Demolition
- ▶ Scrap Handling & Compaction
- ▶ Rip-rap Handling
- ▶ Road Building & Reconstruction
- ▶ C & D Sorting
- ▶ Land Clearing



STIFF ARM AND MOUNTING PAD | Comes standard with each GSD



GSD Full Kit

GSD Tine Kit



| Model | Weight* (lbs.) | Capacity (yd ³) | Jaw Opening** (ins.) | Jaw Closed (ins.) | Moveable Jaw Width (ins.) | Lower Jaw Width (ins.) | Excavator Weight (lbs.) |
|---------|-------------------|--------------------------------|-------------------------|----------------------|------------------------------|---------------------------|----------------------------|
| GSD 10 | 555 | 0.5-0.8 | 64 | 7 | 13 | 22 | 10,000-20,000 |
| GSD 30 | 2,110 | 1.5-2.5 | 84 | 8 | 21 | 35 | 24,000-30,000 |
| GSD 40 | 2,620 | 2.0-3.0 | 92 | 9 | 26 | 38 | 30,000-40,000 |
| GSD 50 | 3,300 | 3.0-4.0 | 99 | 10 | 30 | 44 | 35,000-65,000 |
| GSD 70 | 4,430 | 3.5-4.5 | 121 | 12 | 30 | 44 | 65,000-85,000 |
| GSD 90 | 5,950 | 4.5-6.5 | 131 | 12 | 34 | 50 | 85,000-120,000 |
| GSD 140 | 7,500 | 6.5-7.5 | 140 | 15 | 34 | 50 | 120,000-170,000 |
| GSD 170 | 9,600 | 7.5-10.0 | 150 | 16 | 40 | 58 | 170,000-220,000 |
| GSD 250 | 16,500 | 8.5-12.0 | 150 | 16 | 40 | 68 | 220,000-280,000 |

*Weight includes mounting bracket and stiff arm.

**Jaw opening varies slightly depending on excavator mounting location.

Hardox® is a trademark of the SSAB group of companies.

TECHNICAL SERVICE TRAINING

Procedures. Products. People.

Train with the best in the business.
Maximize your productivity and the value
of your attachments.

Designed for Genesis customer and dealer service supervisors and technicians, Technical Service Training provides attendees the maintenance, repair and troubleshooting procedures recommended for their attachments.

Held in Superior, WI, the two-day sessions feature not only classroom learning but also a Genesis factory tour, enabling attendees to see first-hand how attachments are built and meet the people who build them. Instructional topics include installation, operation, welding, hydraulics, rotation and swivels.

Classes are typically held April through October, and there is no cost to attend. Attendees are responsible for only their airfare or ground transportation. Genesis covers all other training related expenses.

Class size is limited, so early registration is recommended. However, if there is a large number of people from one organization who want to attend, we may be able to come to you. Customer and dealer on-site training should be discussed and planned with your Genesis Regional Manager.

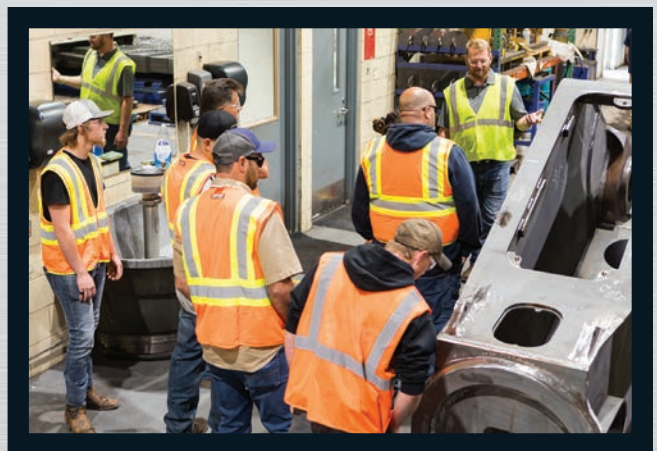

See genesisattachments.com/support/technical-service-training for class dates, registration and complete information.

GENESIS OEM PARTS

Only Genesis Wear Parts provide:

- ▶ Engineered performance
- ▶ Precise OEM fit
- ▶ Extended life



We know attachments are used in the most extreme conditions, and when steel cuts steel or crushes concrete, blades, teeth and other components are going to wear and need to be replaced.

To keep you operating, Genesis offers a complete selection of individual wear parts and wear parts kits for blades and teeth, as well as hydraulic components and maintenance tools and supplies.

MOBILE SHEAR BLADES AND WEAR PARTS KITS

MAXX-NiFe Genesis offers a wide range of premium mobile shear blades for all applications. Maxx-NiFe® high-nickel blades for extreme duty and longer life. Standard blades for typical scrap processing, and serrated blades for a variety of applications including rebar processing and cutting cable.



DEMOLITION TOOL & PROCESSOR TEETH AND WEAR PARTS KITS

We stock an extensive inventory of individual blades, teeth, shims, bolts, nuts and washers in addition to complete wear parts kits for all Genesis demolition and processing attachments.



HYDRAULICS

We have a complete inventory of the highest-grade hydraulic components for all Genesis attachments including swivels, motors, gearboxes, regeneration valves, cartridges, valves, seal kits and hoses.



MAINTENANCE

Genesis has the tools and supplies you need to keep your attachment running — demolition tooth build-up templates, Genrod and Genwire welding supplies, torque wrenches, torque multipliers, sockets, GLG-2® extreme-pressure grease, grinders and other hand tools.



REBUILD SERVICES

Repair. Restore. Rebuild.

Genesis offers complete refurbishment, repair and restoration services that extend attachment life and your return on investment.



EXTEND THE SERVICE LIFE OF YOUR ATTACHMENT

When purchasing a new attachment isn't necessary or even an option, turn to Genesis Rebuild Services. We will extend the life of your worn out attachments by bringing them back to factory specs.

Genesis has quickly repaired and rebuilt hundreds of attachments. And every rebuilt Genesis attachment features a six-month warranty on all repairs.

Contact your Genesis Regional Manager for additional Rebuild Services information or visit genesisattachments.com

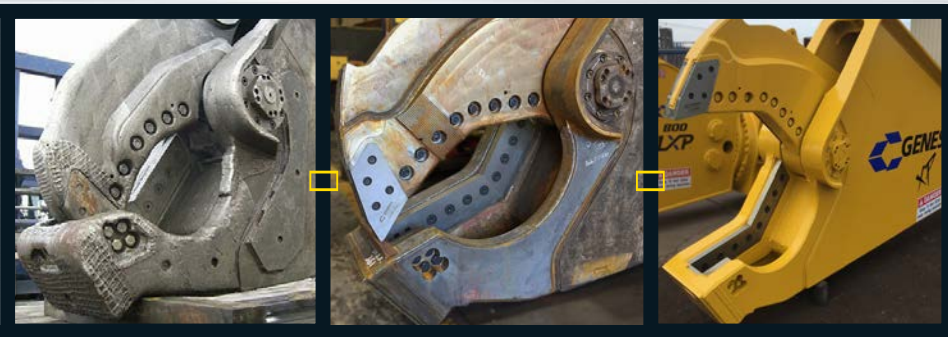

REBUILD COMPONENTS INCLUDE:

- ▶ Upper and lower jaws
- ▶ Main shaft
- ▶ Cylinder
- ▶ Brackets
- ▶ Parent material that no longer supports the blades
- ▶ Upper and lower jaw knife edges that no longer run parallel

SHEAR JAW ARMOR®

Tough. Long-lasting. Reliable.



Attachments protected with Genesis Shear Jaw Armor® and Grapple Jaw Armor not only deliver productivity, uptime and value, but also far exceed normal wear cycles.

Constructed from our proprietary GenGuard steel, the Jaw Armor abrasion-resistant system maintains structural integrity and reduces build-up and hard-surfacing downtime.

- ▶ Reduces downtime and welding maintenance expense
- ▶ Virtually eliminates build-up and hard-surfacing
- ▶ Does not affect shear blade mounting
- ▶ Available on new and for existing attachments

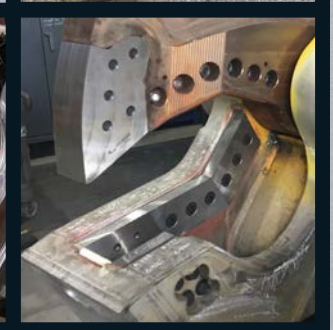
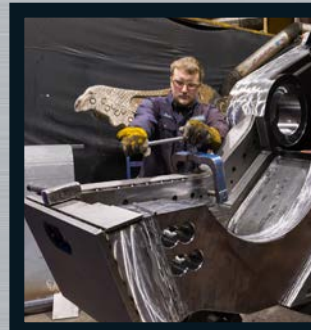
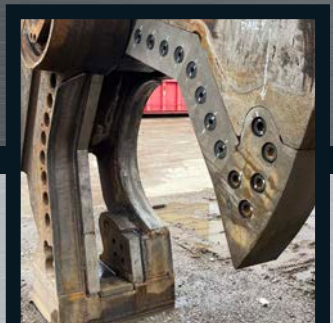

MANUFACTURING

The people and technology behind our Promise of Performance

Making industry-leading attachments that withstand the daily rigors of demolition, scrap processing and material handling applications requires not only the most rugged materials and components, but also highly skilled people and the latest manufacturing technology.

Genesis engineers, welders, machinists and assemblers have years of attachment manufacturing experience and strive to produce only the highest quality shears, processors and grapples.

Our investments in automation, machining and welding equipment, and factory upgrades facilitate accuracy and efficiency as well as promote continuous improvement.

Thanks to our people and technology, Genesis attachments are industry workhorses designed to improve our customers' productivity and profitability for many years. That's our Promise of Performance.

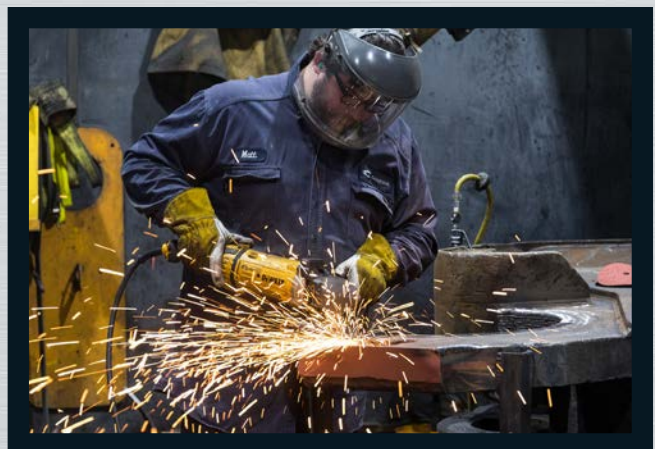
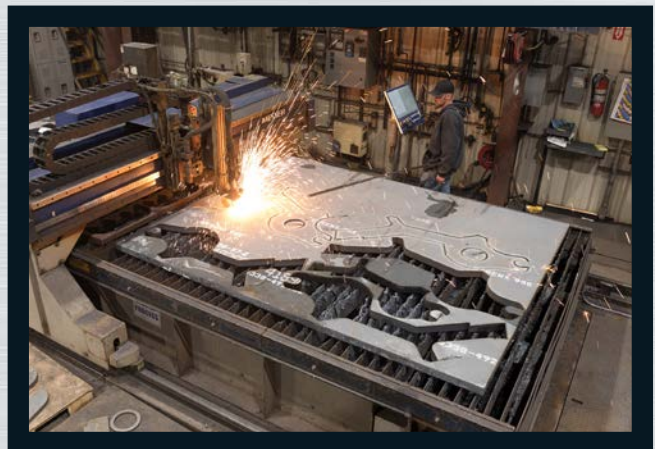
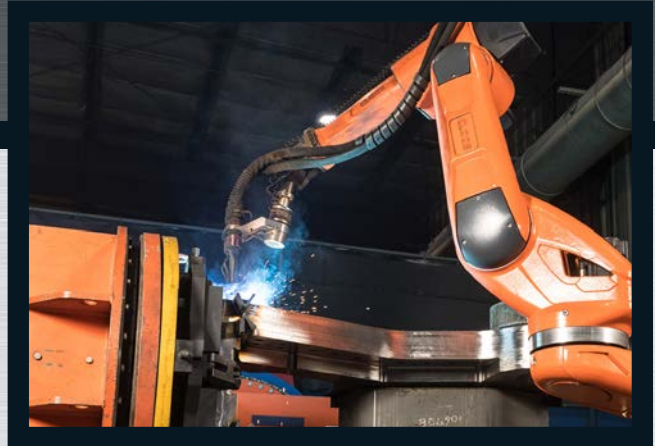

Most Genesis attachments are covered by a 12-month, 1,500-hour (whichever occurs first) warranty. Genesis reserves the right to continually make product improvements designed to positively enhance performance. Patents: [genesisattachments.com/products/patents](https://www.genesisattachments.com/products/patents)

MULTI-MACHINE MOUNTING

Brackets & Rotator Mounting Positions



Genesis offers a variety of mounting brackets to meet your application needs. All mounting brackets can be built to OEM spec, multi-machine and/or transport configuration.

Second-Member

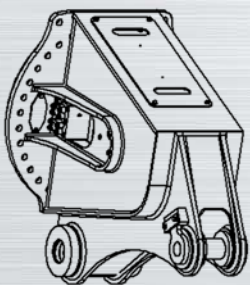

Standard

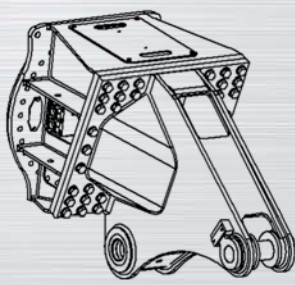

Flat Top

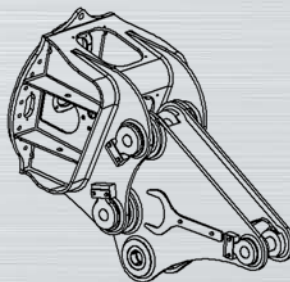

Bracket Adapter
For use with third-member
standard bracket

Third-Member

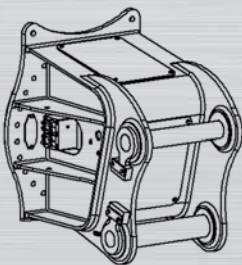

Standard

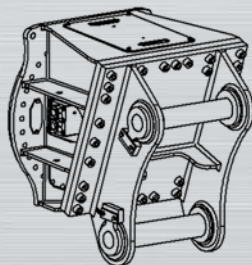

Flat Top

Second-Member Standard versus Transport Configuration

Transport bracket designs allow for ease of mobility or maintenance without having to unpin the stick cylinder. Consult your Genesis Regional Manager for more information.

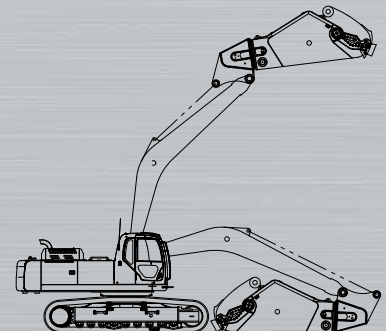
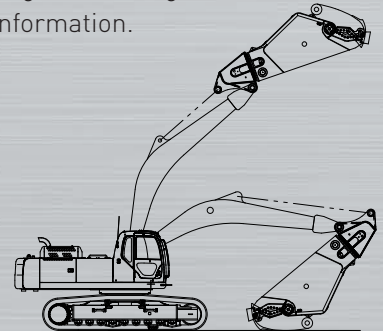

FIND YOUR LOCAL GENESIS DEALER

VISIT THE DEALER LOCATOR AT GENESISATTACHMENTS.COM

GENESIS
The Promise of Performance.

Products Manuals Where to Purchase Support Literature About Us Contact Us **888-SHEAR IT**

US Dealers

54880 **FIND**

Genesis World Headquarters
1000 Genesis Drive
Superior, WI 54880
United States
genesisattachments.com
888-743-2748

Regional Sales Managers **▼** International Dealers **▶**

Genesis Attachments

1000 Genesis Drive
Superior, WI 54880 USA

Toll Free: 888-SHEAR-IT
(888-743-2748)
Phone: 715.395.5252
info@genesisattachments.com

Europe/Africa/Middle East

Genesis GmbH
Teramostrasse 23
87700 Memmingen, Germany

Phone: +49 83 31 9 25 98 0
Fax: +49 83 31 9 25 98 80
genesis-europe.com
info@genesis-europe.com

Asia Pacific Representative Office

24 Upper Serangoon View #12-28
Singapore 534205

Phone: +65 9673 9730
tchoo@genesisattachments.com



The Genesis Product Catalog is published by Genesis Attachments, 1000 Genesis Drive, Superior, WI 54880. Extracts from this literature may be copied or reproduced only with prior approval from the Genesis Marketing Department and if the originator is credited. Genesis' policy is to continually develop and improve products. The Company reserves the right to change product detail and technical specifications without notice.